

uniden®

LRD 6499SWS Operating Guide

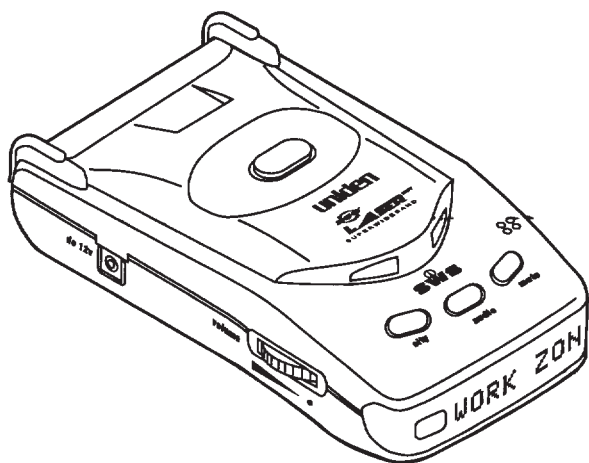

USZZ01067ZZ

Precautions

Important: *The LRD 6499SWS was not designed to help you disobey the law. Safe drivers always obey the posted speed limit and legal driving methods at all times.*

Federal and Local Regulations

The FCC passed the Communications Act in 1934 to give all citizens the right to receive any type of radio transmission. The same radio frequencies used by police radar are also used by other devices, such as automatic door openers, burglar alarms, and some amateur radio equipment. Since the LRD 6499SWS is just a radio receiver tuned to a specific portion of the public radio spectrum, it is protected under this act.

Some local, state, and federal regulations may prohibit the use of this detection device. Please check with authorities regarding the use of this device before operating it.

Operation Notice Safety Warning Systems

You have purchased the newest technology designed for Radar, Laser and Safety Warning System detection and alert. You should be aware that Safety Warning transmitters (the device that alerts your detector for safety warning alerts) will be available for use throughout the United States. However, these transmitters may not be used in all areas.

While this detector is designed to warn you of road hazards, it is not designed as a substitute for safe, attentive driving procedures. Drivers are reminded to remain alert for road hazards at all times.

Contents

Introduction	1
Feature Highlights	1
Speed Detection Systems	2
Radar	2
Laser	3
Included with Your Radar Detector	4
Controls and Functions	5
LED Displays	7
Installation	9
Helpful Tips	9
Adjusting the Windshield Mounting Clip	10
Connecting the Power	11
Replacing the Fuse	12
Operation	13
Power On	13
Volume Control	13
Memory Retention Feature	14
Full Warning	14
Audio/Dimmer Operation	14
Mute Operation	15
City/Highway Operation	16
LED Signal Strength Meter in City Mode	17
Safety Warning System Operation	17
Care and Maintenance	18
Troubleshooting	19
Specifications	20
Replacement Parts	21
SWS Warning Messages	22
Highway Construction	22
Highway Hazard Zone Advisory	22
Weather Related Hazard	23
Travel Information Convenience	23
Fast/Slow Moving Vehicles	23

Features, Specifications, and availability of Optional Accessories are all subject to change without notice.

Uniden® is a registered trademark of Uniden America Corporation.

Introduction

Welcome to the world of sophisticated, early warning laser/radar detection. You have purchased one of the most advanced laser/radar detectors available. The LRD 6499SWS is a complete integrated laser/radar detector. It responds to the X-, K-, and Ka-SuperWideband radar guns in use today and also provides 360° detection of the latest speed monitoring system — the laser gun. The built-in Safety Warning System (SWS™) is capable of detecting a hazardous warning signal transmitted on the K-band and display the message over the eight-digit dot-matrix LEDs.

The LRD 6499SWS provides distinct visual and audio alerts to warn you of the presence of X-, K-, and Ka-SuperWideband radar signals as well as IR laser signals. You can drive with confidence when you bring along the LRD 6499SWS.

The LRD 6499SWS employs Super Stalker Technology (SST), a state-of-the-art electronic system designed to make this radar detector invisible to all current VG-2 radar detector detectors. The LRD 6499SWS also uses the new D.R.O. (Dielectric Resonant Oscillator) and E.D.I.T. (Electronic Data Interference Terminator) circuitry, giving more reliable performance.

We are certain that you will enjoy the LRD 6499SWS, and to ensure that you get the most from its features, please read this Operating Guide carefully before installing and operating the unit.

Feature Highlights

- 360° Laser Detection
- Complete four-Band Coverage
- Super Wideband
- K/Ka Priority
- Signal Strength Meter S1-S6
- Audio/Dimmer Mode
- Memory Retention Feature
- Safety Warning System™ with 8-digit message display
- 5 Alert Tones
- VG-2 Undetectable
- Pulse Detection
- Warning Display
- Auto Mute Mode
- Self Test
- City and Highway Modes

Speed Detection Systems

A speed detection device (often called a radar gun) sends out either a microwave signal or beam of light. When this signal reaches its target, part of the signal is reflected or bounced back toward the emitting gun. The time required for the signal to leave the gun, bounce off an object, and return is used to determine a vehicle's distance and speed.

Radar

Radar (Radio Detection and Ranging) is a microwave system for detecting the speed of moving objects by reflected pulses of high frequency radio waves. There are three radar bands (microwave frequencies): X-band (10.49 to 10.56GHz), K-band (24.04 to 24.26 GHz), and the "SuperWide" Ka-band (33.4 GHz to 36 GHz).

The X-band was the first used for traffic, followed by the K-band which is harder to detect (most instant-on radar is K-band). The Ka-band was introduced in 1987, and widened to Ka-SuperWideband in 1990 by the FCC. The LRD 6499SWS monitors all current radar bands including the entire Ka-SuperWideband.

The radar beam is cone shaped — the narrower the beam, the greater the resolution. A moving vehicle reflects radar signals back towards the radar gun. The LRD 6499SWS can detect the signals emitted by radar guns, and it will sound an audio alarm and flash a warning indicator.

For continuously transmitting radar, use the LRD 6499SWS to get accurate detection from a safe distance. Weak signals cause the audio and visual alarms to sound intermittently, but as the signal gets stronger (the closer you get to the radar gun), both alarms increase in intensity.

Instant-on transmitters fire a short radar pulse beam at a vehicle and instantly read its speed. When detected at a distance, you will hear a few beeps and see the strength meter begin to light. Instant-On radar signals are the most difficult to detect at a safe distance because they are transmitted only when directed at you or at a vehicle directly ahead of you.

Laser

The Laser Speed Detection System, also called LIDAR (for **L**ight **D**etection and **R**anging), uses a laser gun that emits infrared light pulses just outside the spectrum of visible light. Each reflected pulse measures the speed of the object coming toward, or going away from, the laser gun.

Unlike radar, the laser gun emits a very narrow beam of light, so it can pinpoint a speeding car within traffic. The infrared beam spreads out, but slowly and over a longer distance than a radar signal.

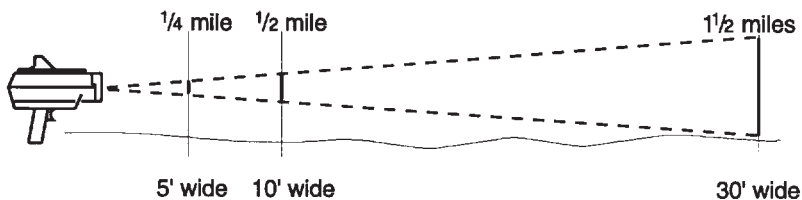

The laser gun can acquire a speed reading as quickly as 0.3 seconds, sometimes less. However, since it isn't easy to accurately aim at and hit a moving target, an operator often moves the laser gun in several directions to get a reading. So laser signals are emitted continuously for a few seconds for each speed measurement. The LRD 6499SWS can detect these light pulses from as far away as 1.5 miles, which is about four times the effective range of a laser gun (2,000 feet), and about ten times its average operating range (500-800 feet).

Note: *To be safe, do not ignore any warnings. Although there are other types of radar signals that may cause interference, when the LRD 6499SWS detects a signal, be on the alert. It is important to exercise caution at all times.*

Included with Your Radar Detector

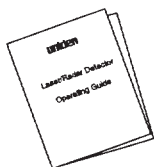

Owner's Guide

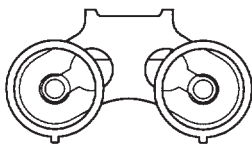

Windshield Mounting
Clip



Printed Material

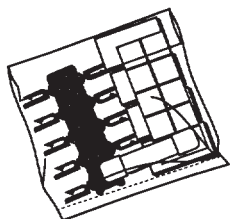

Fuses and Spare Parts

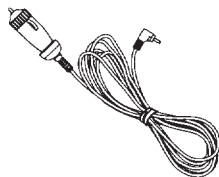

Straight Power Cord

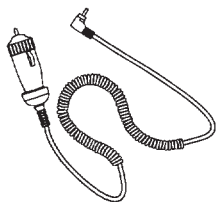

Coiled Cigarette
Adapter

If any of these items are missing or damaged, contact your dealer immediately. Be sure to complete and mail the Product Registration Card.

Controls and Functions

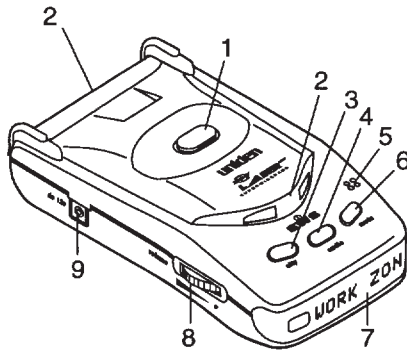

1. **Clip Release** — Press the clip release button to remove the LRD 6499SWS from the windshield mounting clip.
2. **Rear, Side, and Front Laser Detector Lenses** — For rear, side, and front detection of laser signals.
3. **CITY Button** — With each press, the mode toggles from Highway to City mode. The CITY button helps reduce X-band false alarms while driving in the city. Select HIGHWAY for long range detection. Depending on the mode selected, either CTY or HWY will display in the LED Display.
4. **AUDIO Button** — With each press, the mode toggles from DIMMER (LEDs dim only), to AUDIO (turns off LED display except mode indication and dims the Three-Color LED), to NORMAL (LED display and audio on).
5. **Speaker** — Sounds audio alert. There are five different audio alert tones to distinguish each type of signal received. When you become familiar with all the distinct alert tones, you can operate the LRD 6499SWS just by listening, devoting your full attention to driving.
6. **MUTE Button** — Press the MUTE button to activate the Auto Mute feature, which produces a full alert tone when a signal is first received, then automatically reduces to half volume. If activated in City mode, an alert sounds for signal levels S3 (see page 17) and above then reduces to Mute tone.

7. LED Display — LEDs display LASER/RADAR alerts, signal strength, operation mode, and Safety Warning System (SWS) messages.
8. On-Off/Volume Control — Turns the power on (with a click) and adjusts the Audio alert volume.
9. 12V DC Power Input — Connect the DC power cord here.

Note: Use on a Uniden® supplied power cord or its replacement.

LED Displays

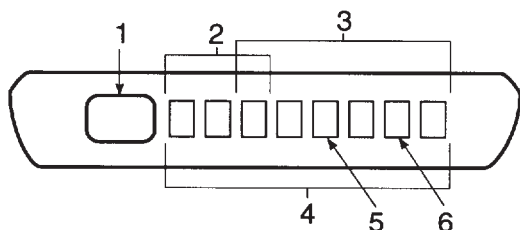

1. **Three-Color LED** — Red indicates a radar detection; Green indicates a laser detection; and Amber indicates a Safety Warning System(SWS) message.
2. **Band and City/Highway Mode** — The first three LEDs indicate X-, K-, Ka-SuperWideband radar signal, and City or Highway mode. If a laser signal is detected, LASER will display in the first five LEDs while the remaining LEDs light. A distinct audio alert is heard for radar and laser signals.
3. **LED Signal Strength Meter (S1 to S6)** — Starting with the third LED position (S1), as the signal gets stronger, additional LEDs will light. See page 17, LED Signal Strength Meter in City Mode.
4. **Safety Warning System (SWS) Display** — All eight LEDs display SWS messages. Messages longer than eight-digits are scrolled repeatedly. When SWS data is received and cannot be specified, 'SAFETY WARNING MESSAGE' displays. A distinct audio alert is heard for SWS messages.
5. **Dimmer/Audio Mode** — The fifth LED position indicates Dimmer (D) or Audio (A) mode. Dimmer mode dims the LEDs but displays all possible data. Audio mode disables signal displays and dims the Three-Color LED.
6. **Mute Mode** — The seventh LED position indicates Mute (M) mode. Signals received sound for a few seconds then are reduced to half the normal tone (Mute tone).

When a Ka-band is received with a signal strength of 4:



Red

When City, Audio, and Mute modes are turned on

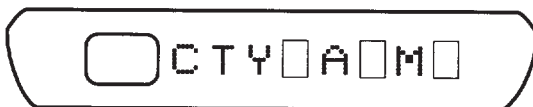

When a SWS message 'ROAD CLOSED AHEAD' is received:

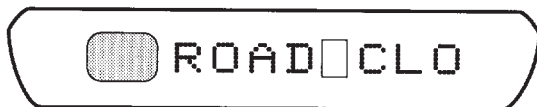

Amber

1. The first eight characters display for about two seconds.
2. The message scrolls to the left at the rate of 300 msec/character.
3. Scrolling stops at the end of the message and the display turns off for one second.
4. The message displays again and repeats scrolling.

Note: Every time you turn on the LRD 6499SWS, a self-test is performed for all LEDs and Alert tones. You will hear in-order five distinct tones for the X-, K-, and Ka-SuperWideband radar bands, Laser, as well as for SWS.

Installation

The LRD 6499SWS uses a highly sensitive horn-type antenna and IR laser sensor to receive radar/laser signals. Its sensitivity and range depend on the method of installation and the direction of the antenna/sensor in relation to the signal source. The inherent nature of radar waves makes them reflect off metallic surfaces. This is why these waves are so useful for measuring the speed of a vehicle. The IR laser light may reflect only from shiny surfaces. Both radar waves and IR laser light will, however, pass through plastic or glass.

Before you decide where to put your radar detector, please keep in mind these two important factors:

- For safety, do not mount the LRD 6499SWS in a location where it will obstruct your driving vision.
- Most vehicles have the top part of the windshield tinted. Mounting the LRD 6499SWS behind tinted or mirrored glass may reduce the effectiveness of laser detection by reducing the amount of laser light received by the Detector.

Helpful Tips

The antenna and the forward looking sensor are located behind the rear panel of the unit, (and the rear- and side-looking sensors are located on top of the unit), directly behind the mode selection keys. The antenna and sensors should not be obstructed by metal or metallic surfaces and should be pointed at the horizon for accurate long-range detection.



- Do not mount the unit behind the windshield wiper blades, radio antenna, tinted glass area, or mirrored glass. Be sure the unit is free from obstruction by seat backs, rear view mirror, sun visors, or the ceiling of the automobile.
- Do not mount the unit in front of the heater or defroster vents.
- Do not leave the unit in direct sunlight or in the glove compartment of a closed car for long periods of time, as extreme changes in temperature may cause internal damage. Also, removing the unit from the windshield makes you less susceptible to break-in and theft.

Adjusting the Windshield Mounting Clip

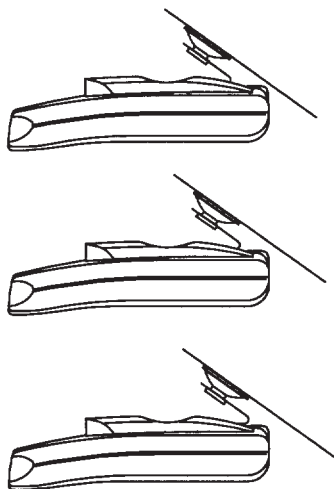

1. The metal portion of the bracket locks into the plastic portion at three different positions. These positions can be used for vehicles with different vertical windshield angles. The back position can be used for vehicles with windshields that are slanted back.
2. For optimum laser detection, bend the angled portion of the windshield mounting bracket so that the LRD 6499SWS is parallel to the road surface. Be sure the LRD 6499SWS is mounted so it is free of obstructions from seat backs, rear view mirror, sun visors, or the ceiling of the automobile. There must be a clear 360° line of sight to the outside of the vehicle.

To mount the LRD 6499SWS:

1. Insert the windshield clip into the LRD 6499SWS.
2. Place the bracket and the LRD 6499SWS in the proper location on the windshield of your vehicle, and press the suction cups firmly against the windshield.

Connecting the Power

The LRD 6499SWS is designed to operate on most 12 VDC negative ground vehicle electrical systems. The power cord provided with the unit has a cigarette lighter socket plug at one end and a small connector at the other.

1. Insert the small connector into the jack on the side of the unit.

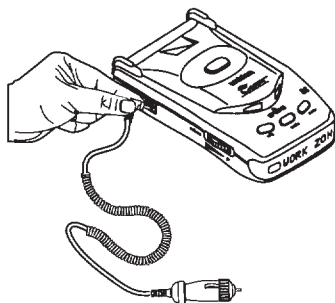

2. Insert the other end into the cigarette lighter socket of your vehicle.

When installing the power cord, make sure that:

- The socket is clean to allow proper contact.
- The power cord does not block the antenna area on the back of the unit.

Your unit also comes with ten power cord mounting clips. You can use these clips to attach the power cord to the window frame or other parts of the vehicle, keeping it neat and out of the way. Use the double-sided foam tape squares to attach each clip. Slip the power cord into the clip to hold it securely in place.

Replacing the Fuse

The cigarette lighter plug contains a 1-ampere fuse to protect it from power surges.

1. To replace the fuse, unscrew the top of the plug.



2. Remove the fuse and replace it with the same type.

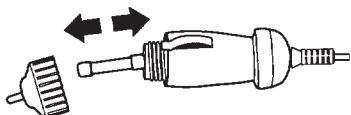

3. To replace the top, push in the two metal contacts and twist into place.

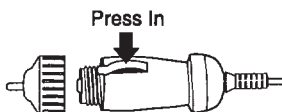

Note: *Your LRD 6499SWS comes with an extra fuse.*

Operation

You are now ready to enjoy the convenience and security of your LRD 6499SWS. Please read this section of the Operating Guide carefully to familiarize yourself with the basic operation of this unit.

Power On

Turn the Volume Control to switch on the power (with a click). The Power-On alert sounds. The LRD 6499SWS performs a six second self-test of all circuits. First the X-band alert sounds for two seconds while the Three-Color LED illuminates red, and the Signal Meter LED will light. Next you will hear the K-band, Ka-SuperWideband, Laser, and SWS alerts for one second each. Their corresponding Three-Color LEDs and the City/Highway, Audio/Dimmer, and Mute indications will light.

After the LRD 6499SWS confirms proper operation, each status of City/Highway, Audio/Dimmer, and Mute modes remains the same as when last used. Factory settings are City mode: HWY; Audio mode: OFF; Mute mode: OFF.

If the following problems occur, be sure both ends of the power cord are tight. Otherwise review the page 19, Troubleshooting.

- Settings are not displayed
- The unit turns on and off intermittently
- An alert sounds too often for no reason

Volume Control

Adjust the Volume control to a comfortable alarm tone level for your vehicle. The volume level does not have any effect on the unit's sensitivity.

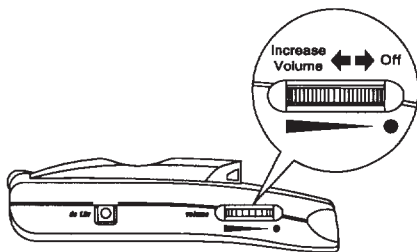

Memory Retention Feature

The Memory Retention Feature retains the LRD 6499SWS's operational settings in memory for at least two days without power. When you turn on the LRD 6499SWS, it will be in the same mode as when you turned it off.

Full Warning

When the LRD 6499SWS detects a radar, laser, or safety warning signal, it emits a distinct warning tone and the corresponding X-, K-, Ka-SuperWideband, Laser, or SWS indication will display along with illuminating the corresponding red, green or amber Three-Color LED. For radar, as the signal gets stronger, more signal strength LEDs (S1 to S6) will light.

Audio/Dimmer Operation

Press the AUDIO button to toggle from Dimmer, to Audio, to Normal mode. A beep sounds to confirm each mode change. A or D displays in the LED display.

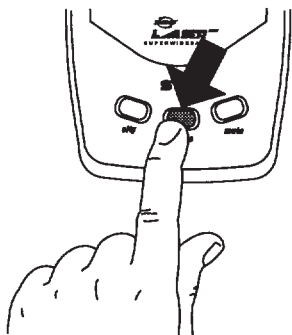

Press the AUDIO button to select Dimmer mode. The LEDs dim, while displayed information is the same as in Normal mode. Press the AUDIO button again to select Audio mode. The Radar/Laser/SWS and Signal Strength Meter indications are disabled. Only City/Highway, Audio, and Mute mode (if selected) are displayed. This mode dims the three-color LED. Pressing the AUDIO button again returns to Normal mode. This sequence repeats in this order. (Do not set the Volume control at minimum when in Audio mode since there will be no display).

Note: *The audio alert tones for the three radar bands, laser, and SWS are all different.*

Mute Operation

Press the MUTE button to activate and deactivate Mute mode. A beep sounds to confirm each mode change. M displays in the LED display.

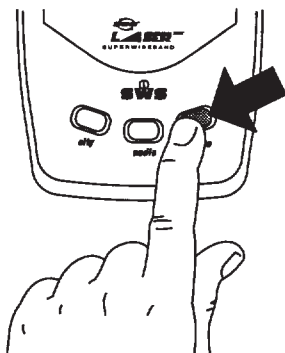

In Mute mode you hear the full audio alert for several seconds when a signal is first received. The alert automatically reduces to half volume (Mute tone) for the duration of the warning. Press the MUTE button when an alert sounds to reduce the alert to Mute tone.

City/Highway Operation

In highly populated areas, you may encounter many devices that use the same frequencies as radar signals, such as motion detectors, automatic doors, and intrusion alarms. These devices may trigger an alert called “falsing.”

Press the CITY button to toggle between City and Highway. A beep sounds to confirm each mode change. CTY or HWY displays in the LED display.

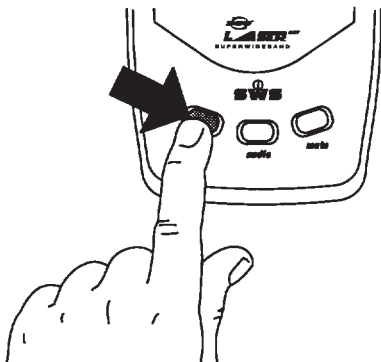

City mode is used to filter most of the weaker signals and get the most accurate radar signal recognition. In City mode, the combination of visual and audio alert tones varies based on the strength of the signal received (S1 to S6).

Note: *If you use both Mute mode and City modes, you won't receive an alert until you are very close to the radar source.*

LED Signal Strength Meter in City Mode

The LED signal strength meter gives you instant information about the strength of the signal being detected. A weak signal causes the first LED (third LED position, S1) to light, but as signal strength increases, additional LEDs light. All six LEDs (S1 through S6) light when full signal strength is received. Use this meter to judge the distance from the signal source.

Signal Strength (S1 to S6)	X-, K-, and Ka-Super WideBand	Laser*
●○○○○○	Visual	Audio
●●○○○○	Visual	Audio
●●●○○○	Visual/Audio	Audio
●●●●○○	Visual/Audio	Audio
●●●●●○	Visual/Audio	Audio
●●●●●●	Visual/Audio	Audio

***Note:** *Signal Strength for the Laser level is not displayed, only 'LASER' displays in the LEDs with an alert.*

Safety Warning System Operation

The Safety Warning System (SWS™) is a new communication system that will provide an early warning when a road hazard exists. The LRD 6499SWS is capable of detecting SWS signal broadcasts on the K-band by either law enforcement or local departments of transportation. The Three-Color LED illuminates amber and the eight-digit LEDs scroll the message, while an alert sounds. Messages greater than eight-characters will scroll repeatedly. When two messages are received, they are alternately scrolled. If the LRD 6499SWS cannot specify the message, 'SAFETY WARNING MESSAGE' is displayed. If the complete message cannot be received in a certain amount of time, the first eight-characters will flash.

Important: *Your unit only displays safety warning messages when it receives signals from an active Safety Warning System transmitter.*

Care and Maintenance

The LRD 6499SWS is designed to give you years of trouble-free service. There are no user-serviceable parts inside, and, except for the fuse, no maintenance is required. To keep your detector in new condition, follow these important suggestions:

- Never leave the LRD 6499SWS on the windshield when you park your vehicle. The temperature in the vehicle in summer can reach levels above what is considered safe for this unit.
- To make you less susceptible to break-in and theft, remove the unit from your windshield when you leave your vehicle.
- Do not expose the unit to moisture. Rain, dew, road splash, or other liquids can damage the internal components and reduce sensitivity of the LRD 6499SWS.

Troubleshooting

If your LRD 6499SWS does not perform up to expectations, try the suggestions listed below. If you cannot get satisfactory results, call the Uniden Customer Service Center at (800) 297-1023, 8:00 a.m. to 5:00 p.m. Central Time, Monday through Friday.

Unit does not operate:	<ul style="list-style-type: none"> • Check the power cord. Be sure the connectors are properly installed. • Be sure ignition key is ON or in the accessory position. • Fuse out. Check and replace. • Check power to lighter socket. • Vehicle electrical problem exists. • Make sure that the volume control is in the ON position. • Clean cigarette lighter socket.
Unit fails the self test.	<ul style="list-style-type: none"> • Call Uniden Customer Service Center, (800) 297-1023.
Weak detection.	<ul style="list-style-type: none"> • Check angle of unit. Point to the horizon. • Antenna/Sensor is obstructed. Relocate the unit clear of any obstruction outside the windshield, such as a wiper blade. • Relocate the unit clear of the window tint.
Inaccurate or erratic detection:	<ul style="list-style-type: none"> • Loose power cord. Check both connectors. • Power cord is broken. Check and replace.
Beeps over bumps or rough road.	<ul style="list-style-type: none"> • Check that the power cord is connected at both ends. • Clean cigarette lighter socket.
Beeps at same location.	<ul style="list-style-type: none"> • Falsing because you have passed a motion sensor or alarm.
Signal strength meter registers, but no audio.	<ul style="list-style-type: none"> • For highway use, make sure the Highway mode is ON. • Increase the volume.
The unit bounces against the windshield.	<ul style="list-style-type: none"> • Reposition so that the bumpers are firmly against the windshield.

Specifications

General

Dimensions:	3 1/9 in.(W) x 4 5/8 in.(D) x 5/6 in.(H)
Weight:	3.5 oz.
Power Requirements:	13.8 VDC
Temperature Range:	Operating: -5°F to 160°F (-20°C to 70°C) Storage: -40°F to 185°F (-40°C to 85°C)

360° Laser Detector

Receiver Type:	Pulse Laser Signal Receiver
Sensor Front End:	Convex Condenser Lens
Detector Type:	Pulse Width Discriminator
Receiver Bandwidth:	30 MHz
Spectral Response:	800 - 1100 nm
Alert Hold Time:	3 seconds

Radar Detector

Receiver Type:	Double Conversion Superheterodyne Self-Contained Antenna
Detector Type:	Scanning Frequency Discriminator
Antenna Type:	Linear polarized, E vector vertical
Sensitivity:	X-band = -114 dBm/cm ² K-band = -104 dBm/cm ² Ka-SuperWideband = -100 dBm/cm ²
Frequency of Operation:	10.490 - 10.560 GHz (X-band) 24.040 - 24.260 GHz (K-band) 33.40 - 36.00 GHz (Ka-SuperWideband)

Specifications are subject to change without notice.

Replacement Parts



Owner's
Guide

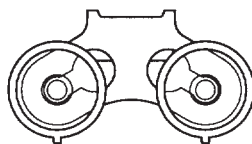

Windshield Mounting
Clip



Printed Material

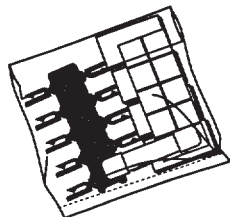

Fuses and
Spare Parts

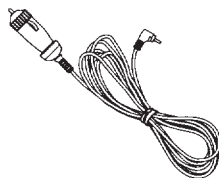

Straight Power Cord

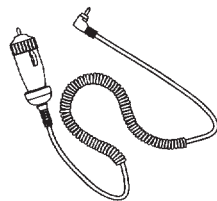

Coiled Cigarette
Adapter

SWS Warning Messages

Highway Construction

WORK ZONE AHEAD
ROAD CLOSED AHEAD / FOLLOW DETOUR
BRIDGE CLOSED AHEAD / FOLLOW DETOUR
HIGHWAY WORK CREWS AHEAD
UTILITY WORK CREWS AHEAD
ALL TRAFFIC FOLLOW DETOUR AHEAD
ALL TRUCKS FOLLOW DETOUR AHEAD
ALL TRAFFIC EXIT AHEAD
RIGHT LANE CLOSED AHEAD
CENTER LANE CLOSED AHEAD
LEFT LANE CLOSED AHEAD

Highway Hazard Zone Advisory

TRAIN APPROACHING / AT CROSSING
LOW OVERPASS AHEAD
DRAWBRIDGE UP
OBSERVE BRIDGE WEIGHT LIMIT
ROCK SLIDE AREA AHEAD
SCHOOL ZONE AHEAD
ROAD NARROWS AHEAD
SHARP CURVE AHEAD
PEDESTRIAN CROSSING AHEAD
DEER / MOOSE CROSSING
BLIND / DEAF CHILD AREA
STEEP GRADE AHEAD / TRUCK USE LOW GEAR
ACCIDENT AHEAD
POOR ROAD SURFACE AHEAD
SCHOOL BUS LOADING / UNLOADING
NO PASSING ZONE
DANGEROUS INTERSECTION AHEAD
STATIONARY EMERGENCY VEHICLE AHEAD

Weather Related Hazard

HIGH WIND AHEAD
SEVERED WEATHER AHEAD
HEAVY FOG AHEAD
HIGH WATER / FLOODING AHEAD
ICE ON BRIDGE AHEAD
ICE ON ROAD AHEAD
BLOWING DUST AHEAD
BLOWING SAND AHEAD
BLOWING SNOW AHEAD
BLOWING SNOW WHITE AREA AHEAD

Travel Information Convenience

REST AREA AHEAD
REST AREA WITH SERVICE AHEAD
24 HOUR FUEL SERVICE AHEAD
INSPECTION STATION OPEN
INSPECTION STATION CLOSED
REDUCED SPEED AREA AHEAD
SPEED LIMIT ENFORCED
HAZARDOUS MATERIALS EXIT AHEAD
CONGESTION AHEAD / EXPECT DELAY
EXPECT 10 MINUTE DELAY
EXPECT 20 MINUTE DELAY
EXPECT 30 MINUTE DELAY
EXPECT 1 HOUR DELAY
TRAFFIC ALERT / TUNE AM RADIO
PAY TOLL AHEAD
TRUCKS EXIT RIGHT
TRUCKS EXIT LEFT

Fast/Slow Moving Vehicles

EMERGENCY VEHICLE IN TRANSIT
POLICE IN PURSUIT
OVERSIZE VEHICLE IN TRANSIT
SLOW MOVING VEHICLE

One Year Limited Warranty

Important: Evidence of original purchase is required for warranty service.

WARRANTOR: UNIDEN AMERICA CORPORATION (“Uniden”)

ELEMENTS OF WARRANTY: Uniden warrants, for one year, to the original retail owner, this Uniden Product to be free from defects in materials and craftsmanship with only the limitations or exclusions set out below.

WARRANTY DURATION: This warranty to the original user shall terminate and be of no further effect 12 months after the date of original retail sale. The warranty is invalid if the Product is (A) damaged or not maintained as reasonable or necessary, (B) modified, altered, or used as part of any conversion kits, subassemblies, or any configurations not sold by Uniden, (C) improperly installed, (D) serviced or repaired by someone other than an authorized Uniden service center for a defect or malfunction covered by this warranty, (E) used in any conjunction with equipment or parts or as part of any system not manufactured by Uniden, or (F) installed or programmed by anyone other than as detailed by the Operating Guide for this product.

STATEMENT OF REMEDY: In the event that the product does not conform to this warranty at any time while this warranty is in effect, warrantor will repair the defect and return it to you without charge for parts, service, or any other cost (except shipping and handling) incurred by warrantor or its representatives in connection with the performance of this warranty. **THE LIMITED WARRANTY SET FORTH ABOVE IS THE SOLE AND ENTIRE WARRANTY PERTAINING TO THE PRODUCT AND IS IN LIEU OF AND EXCLUDES ALL OTHER WARRANTIES OF ANY NATURE WHATSOEVER, WHETHER EXPRESS, IMPLIED OR ARISING BY OPERATION OF LAW, INCLUDING, BUT NOT LIMITED TO ANY IMPLIED WARRANTIES OF MERCHANTABILITY OR FITNESS FOR A PARTICULAR PURPOSE. THIS WARRANTY DOES NOT COVER OR PROVIDE FOR THE REIMBURSEMENT OR PAYMENT OF INCIDENTAL OR CONSEQUENTIAL DAMAGES.** Some states do not allow this exclusion or limitation of incidental or consequential damages so the above limitation or exclusion may not apply to you.

LEGAL REMEDIES: This warranty gives you specific legal rights, and you may also have other rights which vary from state to state. This warranty is void outside the United States of America.

PROCEDURE FOR OBTAINING PERFORMANCE OF WARRANTY: If, after following the instructions in this Operating Guide you are certain that the Product is defective, pack the Product carefully (preferably in its original packaging). Include evidence of original purchase and a note describing the defect that has caused you to return it. The Product should be shipped freight prepaid by traceable means, or delivered, to warrantor at:

Uniden America Corporation

Parts and Service

4700 Amon Carter Blvd.

Fort Worth, TX 76155

(800) 297-1023, 8:00 a.m. to 5:00 p.m. Central Time, Monday through Friday

Covered under one or more of the following U.S. patents:

4,622,553 4,698,632 4,709,407 4,791,420

4,831,498 5,315,302

uniden®

©1996 Uniden America Corporation. All rights reserved.

Printed in the Philippines